



RESTORATION ELIGIBILITY WHITE PAPER

# IS YOUR ROOF A GOOD CANDIDATE FOR RESTORATION?

*Eight questions to help you find out.*



**INTEGRATED  
DIAGNOSTICS  
PROVIDE  
TECHNICAL  
INSIGHT**

**TREMCO**  
ROOFING & BUILDING MAINTENANCE



# DON'T REPLACE YOUR ROOF UNTIL YOU HAVE THE FACTS

*Restoration might be your best option.*



Not every failing roof needs to be replaced. With today's advanced restoration technologies, old and failing roofs can often be saved if they meet certain construction and condition criteria. Before you replace, it's important to get the answers to these questions from a trusted roofing expert who can provide the unbiased facts you need to make the right decision. You might be surprised to learn that a roof you thought had to be replaced can instead be restored for significant financial and environmental benefits.

## 1

### WHAT IS MY EXISTING ROOF MADE OF?

After the visual inspection, **core samples** must be taken to determine roofing system components, including deck type, existence of a vapor retarder, insulation type and thickness, and roof membrane type. Understanding general system construction will direct

what restoration approaches and product options are possible for your project. Certain types of roof systems make better restoration candidates than others. Under the right circumstances, single ply, MB, BUR and metal roofs can be excellent contenders for restoration.

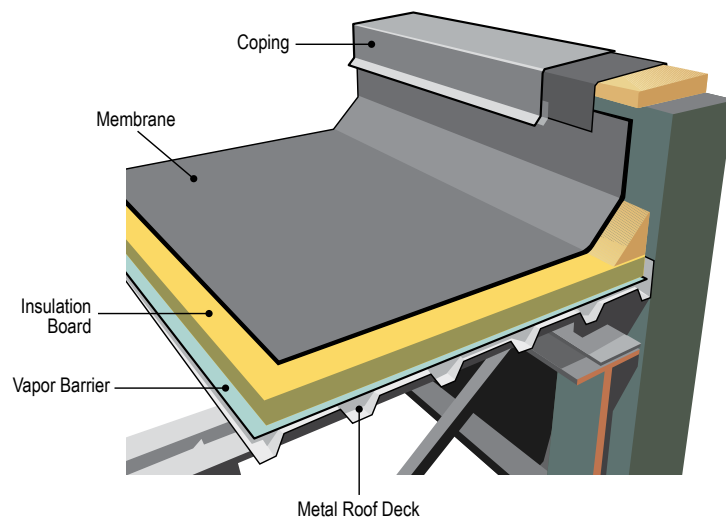

## 2

### IS MY OLD ROOF STRONG ENOUGH TO RESTORE?

Knowing the condition of existing roof layers is a primary step to determining restoration eligibility. A roof is not engineered to be a static entity; changes in temperature, wind force, the weight of rain and snow and other factors require it to expand and contract. Over time a roof system can be weakened by these forces. For many roof types, core samples are an effective way to get essential answers. Laboratory testing will define several conditions, including:

- Tensile strength—the current roof's ability to resist loads without degradation of the membrane and other elements.
- Elasticity—the ability to be stretched and return to its original shape.
- Adhesion peel tests on membrane roofs will indicate how firmly the original layers remain bonded to each other. This test helps determine the strength remaining in the membrane itself.

Many existing roofs pass these tests successfully, making them excellent restoration candidates.

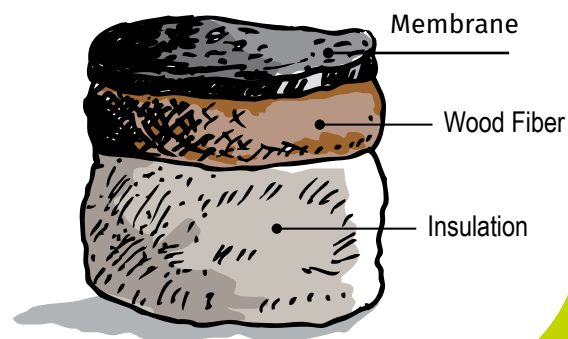

# 3

## WHAT SHAPE IS THE DECK IN?

The deck is the structural foundation of your roof; it may be metal, concrete, gypsum or even wood. It must be inspected from inside the building to determine its condition. It is critical to know if the deck is strong enough to support the existing structure along with any layers that

may be added during restoration. Moisture is also a concern because it can make its way through various layers and become trapped in the insulation. In some cases, these unseen breaches begin to damage the roof deck itself, adding the potential for significant structural failures and repair costs.

Where warranted, best practice is to have a structural analysis performed before deciding how to proceed. All successful restorations rely on a solid deck ready to support the roof for decades to come. If your deck is sound, restoration may be a good option.

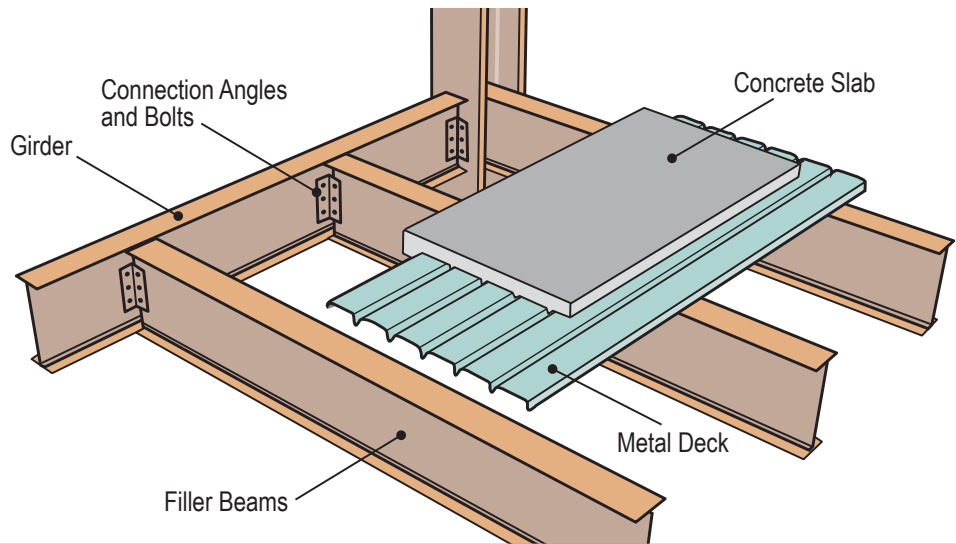

# 4

## DO I ALREADY HAVE TWO ROOFS ON TOP OF EACH OTHER?

If a second roofing system was already installed on top of the first, building codes may limit your restoration options. Core data—and advice from a roofing expert—will help identify your restoration possibilities. In some situations, the concern is weight. Can the building structure withstand the added weight of another roof layer? Construction quality of the first and second roofs is an additional consideration.

How did they interact over many years together? Incorrect installation and incompatible roofing materials can create leaks and other issues. So it is imperative to have a structural analysis performed before proceeding. The good news is these concerns can often be overcome in the restoration process, resulting in a solution that delivers savings and enhanced performance.

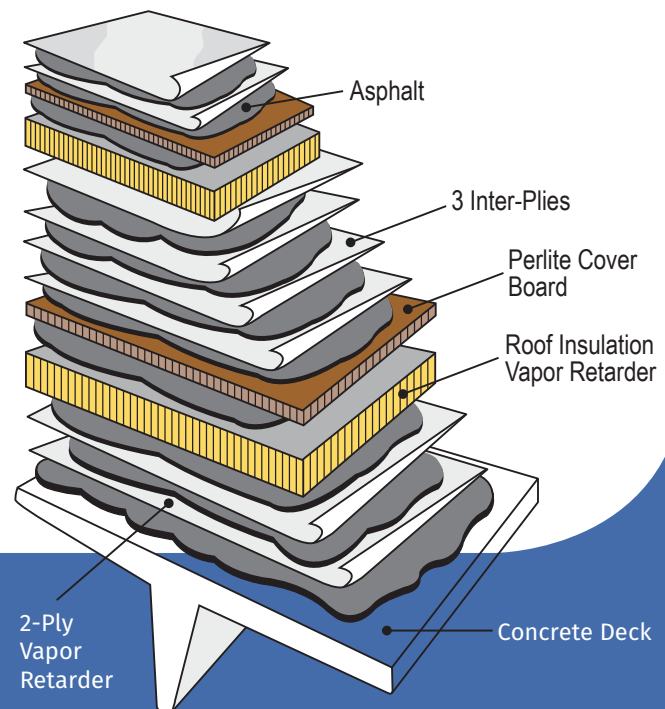

**Determining restoration eligibility requires more than visual inspection. Make sure you're utilizing the most advanced technology in the evaluation process.**

# 5

## IS THE INSULATION WET?

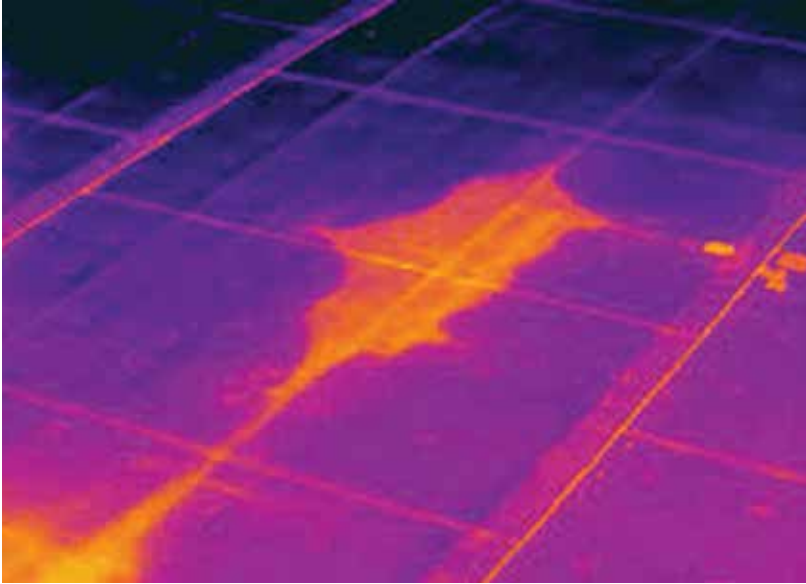

Wet insulation is a critical factor in determining a roof's restorability. No restoration system or product should be applied over wet insulation, even when the roof membrane is functioning. In addition to moisture meter testing, infrared and nuclear analysis are two particularly helpful tools. Infrared roof moisture surveys produce color images called thermograms that show the location of moisture and indicate the location of small holes in the membrane; testing must be performed at night. Infrared drones gather data for both roof and wall surfaces over vast areas, making them a good choice for large buildings and structures that are difficult to access. Nuclear roof moisture testing is another highly accurate method that can be performed during the day, as it uses a nuclear gauge to identify where water is located. Density readings with this tool record as deep as 8" into the roof system, providing incredibly valuable information. Knowledge from these tests can make it possible to remove the damaged wet insulation and keep the dry, saving a considerable expense and making restoration a good possibility.

# 6

## DO I HAVE ASBESTOS IN THE OLD ROOF?

Asbestos is to be anticipated when dealing with older BUR systems, since asbestos was at one time routinely used in flashing plies, roofing plies and flashing mastics. If you have asbestos and the roof is restorable, you'll avoid the significant expense of asbestos removal and disposal because restoration encapsulates the asbestos. Core samples are the primary diagnostic tool for detecting asbestos; they must be performed by an accredited inspector and reviewed in an accredited lab. When conditions allow, restoration of an asbestos-filled roof is a great choice for both the budget and the environment. Encapsulating asbestos is an accredited treatment practice versus removal and disposal.

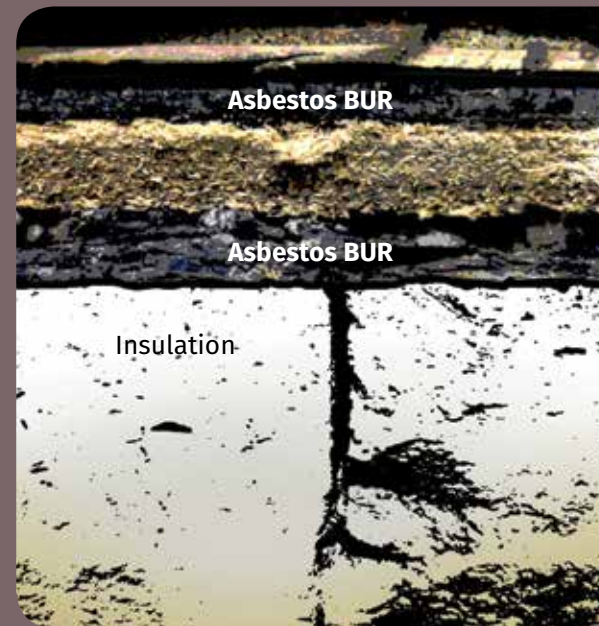



# 7

## IS MY MASONRY AN ISSUE?

Before you restore or replace a roof, examine the masonry. If you restore the roof and water still leaks into your building because of masonry defects, the restoration effort and expense have been wasted. Parapet walls, chimney stacks, elevator shafts and roof access doorways usually have masonry elements that can become victim to infiltrating water. Adjacent masonry should undergo RILEM tube water testing to make sure that any existing leaks along walls are not the result of porous brick, block or mortar. Color thermograms from an infrared roof moisture survey are helpful here as they are on the roof surfaces. On large buildings with difficult access issues, a drone system can be used to remotely capture vast amounts of wall area in infrared images that pinpoint where water is infiltrating. Addressing the masonry issues is an essential aspect of any restoration project.

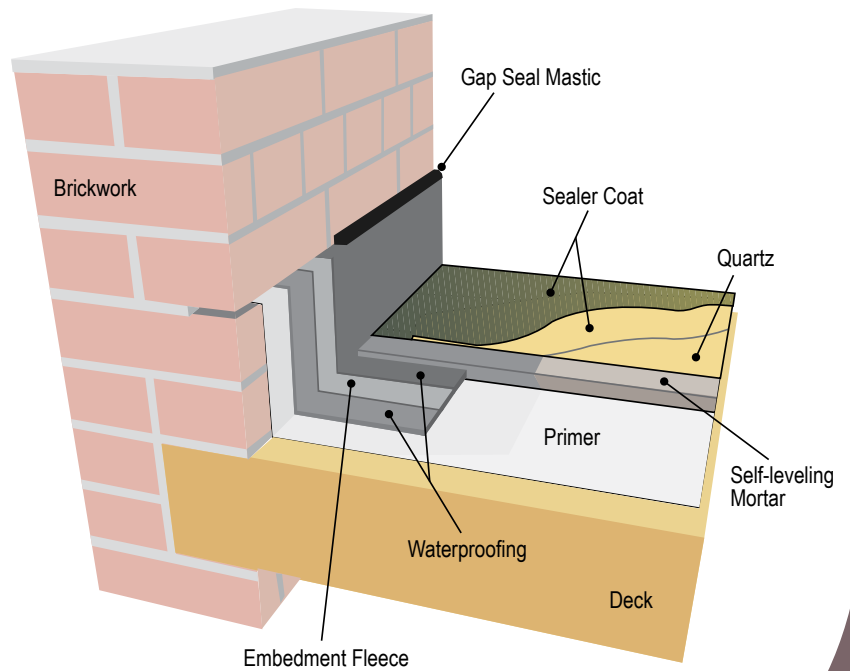

# 8

## WHAT ARE THE BENEFITS OF ROOF RESTORATION VERSUS REPLACEMENT?

While there's no one-size-fits-all solution to failing roofs, there's a good chance your roofing systems can be restored if you get to them quickly enough with the correct technical solutions. Before investing in a roof replacement, consider these benefits of roof restoration:

- Savings as much as 50% compared to typical replacement costs
- Installation is typically faster and easier, requiring less labor
- Much less disruptive to building occupants than total roof replacement, which includes tearing off the old roof
- Restoration reduces landfill waste, which helps the environment and organizations with sustainability goals
- The industry's best restoration solutions include low-odor and no-odor systems, which make restoration a viable solution for even the most sensitive environments
- Restoration expenses may be funded through operational, versus capital budgets

### GET THE FACTS FIRST.

Before deciding the fate of an existing roofing system, test it. Confirm construction type and all relevant conditions so you know what's possible before specifications are written. The upfront diagnostics investment—typically 5¢ to 10¢ per square foot—is well worth the cost relative to the ultimate cost savings.

# Advanced diagnostics are the key to determining if a roof is restorable.



**CORE  
SAMPLE  
ANALYSIS**



**MOISTURE  
PROBE TESTING**



**NIGHTTIME  
INFRARED ROOF  
MOISTURE SURVEYS**



**NUCLEAR  
MOISTURE  
SURVEYS**





**Why replace a roof if it can be restored for significant cost savings, environmental benefits and a comprehensive warranty?**

# Consider Restoration Through a Cooperative Purchasing Solution

If you are a public entity and a member of a purchasing cooperative, you already understand the benefits of procuring products and services—including roof restoration—through cooperative contracts.

Tremco Roofing and Building Maintenance and affiliated construction services company WTI are proud to hold several cooperative purchasing contracts that provide streamlined procurement with assured value and transparency.

**If you'd like to learn more or request a consultation with a Tremco Field Advisor  
Visit [YourRoofExperts.com](http://YourRoofExperts.com) | Call 888.657.7752**



**Cooperative Contracts**  
TRUST IN EXPERIENCE. STRENGTH IN NUMBERS.